



# STGB20NB41LZ

## N-CHANNEL CLAMPED 20A - D<sup>2</sup>PAK INTERNALLY CLAMPED PowerMESH™ IGBT

TYPE	V <sub>CES</sub>	V <sub>CE(sat)</sub>	I <sub>c</sub>
STGB20NB41LZ	CLAMPED	< 2.0 V	20 A

- POLYSILICON GATE VOLTAGE DRIVEN
- LOW THRESHOLD VOLTAGE
- LOW ON-VOLTAGE DROP
- LOW GATE CHARGE
- HIGH CURRENT CAPABILITY
- HIGH VOLTAGE CLAMPING FEATURE

### DESCRIPTION

Using the latest high voltage technology based on a patented strip layout, STMicroelectronics has designed an advanced family of IGBTs, the PowerMESH™ IGBTs, with outstanding performances. The built in collector-gate zener exhibits a very precise active clamping while the gate-emitter zener supplies an ESD protection.

### APPLICATIONS

- AUTOMOTIVE IGNITION



D<sup>2</sup>PAK

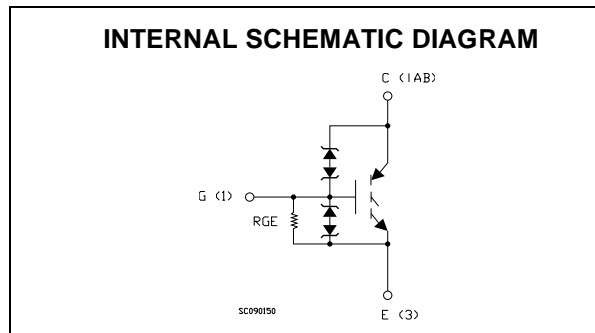

### ORDER CODE

PART NUMBER	MARKING	PACKAGE	PACKAGING
STGB20NB41LZT4	GB20NB41LZ	D <sup>2</sup> PAK	TAPE & REEL

## STGB20NB41LZ

### ABSOLUTE MAXIMUM RATINGS

Symbol	Parameter	Value	Unit
$V_{CES}$	Collector-Emitter Voltage ( $V_{GS} = 0$ )	CLAMPED	V
$V_{ECR}$	Emitter-Collector Voltage	20	V
$V_{GE}$	Gate-Emitter Voltage	CLAMPED	V
$I_C$	Collector Current (continuous) at $T_C = 25^\circ\text{C}$	40	A
$I_C$	Collector Current (continuous) at $T_C = 100^\circ\text{C}$	20	A
$I_{CM}$ (■)	Collector Current (pulsed)	80	A
$E_{as}$	Single Pulse Energy $T_c = 25^\circ\text{C}$	700	mJ
$P_{TOT}$	Total Dissipation at $T_C = 25^\circ\text{C}$	200	W
	Derating Factor	1.33	W/°C
$E_{SD}$	ESD (Human Body Model)	8	KV
$T_{stg}$	Storage Temperature	- 55 to 175	°C
$T_j$	Operating Junction Temperature		

(■) Pulse width limited by safe operating area

### THERMAL DATA

Rthj-case	Thermal Resistance Junction-case Max	0.75	°C/W
Rthj-amb	Thermal Resistance Junction-ambient Max	62.5	°C/W

### ELECTRICAL CHARACTERISTICS ( $T_{CASE} = 25^\circ\text{C}$ UNLESS OTHERWISE SPECIFIED)

OFF

Symbol	Parameter	Test Conditions	Min.	Typ.	Max.	Unit
$BV_{(CES)}$	Clamped Voltage	$I_C = 2\text{ mA}$ , $V_{GE} = 0$ , $T_C = -40^\circ\text{C} \div 150^\circ\text{C}$	382	412	442	V
$BV_{(ECR)}$	Emitter Collector Break-down Voltage	$I_C = 75\text{ mA}$ , $T_C = 25^\circ\text{C}$	20	28		V
$BV_{GE}$	Gate Emitter Break-down Voltage	$I_G = \pm 2\text{ mA}$	12	14	16	V
$I_{CES}$	Collector cut-off Current ( $V_{GE} = 0$ )	$V_{CE} = 15\text{ V}$ , $V_{GE} = 0$ , $T_C = 150^\circ\text{C}$ $V_{CE} = 200\text{ V}$ , $V_{GE} = 0$ , $T_C = 150^\circ\text{C}$			10 100	$\mu\text{A}$ $\mu\text{A}$
$I_{GES}$	Gate-Emitter Leakage Current ( $V_{CE} = 0$ )	$V_{GE} = \pm 10\text{ V}$ , $V_{CE} = 0$	$\pm 300$	$\pm 660$	$\pm 1000$	$\mu\text{A}$
$R_{GE}$	Gate Emitter Resistance		10	15	30	K $\Omega$

ON (1)

Symbol	Parameter	Test Conditions	Min.	Typ.	Max.	Unit
$V_{GE(th)}$	Gate Threshold Voltage	$V_{CE} = V_{GE}$ , $I_C = 250\mu\text{A}$ , $T_C = 25^\circ\text{C}$	1		2.4	V
$V_{CE(SAT)}$	Collector-Emitter Saturation Voltage	$V_{GE} = 4.5\text{ V}$ , $I_C = 10\text{ A}$ , $T_C = 25^\circ\text{C}$ $V_{GE} = 4.5\text{ V}$ , $I_C = 20\text{ A}$ , $T_C = 25^\circ\text{C}$		1.1 1.3	1.8 2.0	V V

## DYNAMIC

Symbol	Parameter	Test Conditions	Min.	Typ.	Max.	Unit
$g_{fs}$	Forward Transconductance	$V_{CE} = 25 \text{ V}$ , $I_C = 20 \text{ A}$		35		S
$C_{ies}$	Input Capacitance	$V_{CE} = 25 \text{ V}$ , $f = 1 \text{ MHz}$ , $V_{GE} = 0$		2300		pF
$C_{oes}$	Output Capacitance			160		pF
$C_{res}$	Reverse Transfer Capacitance			25		pF
$Q_g$	Gate Charge	$V_{CE} = 320 \text{ V}$ , $I_C = 20 \text{ A}$ , $V_{GE} = 5 \text{ V}$		46		nC

## FUNCTIONAL CHARACTERISTICS

Symbol	Parameter	Test Conditions	Min.	Typ.	Max.	Unit
II	Latching Current	$V_{Clamp} = 320 \text{ V}$ , $T_C = 125 \text{ }^\circ\text{C}$ $R_{GOFF} = 1 \text{ K}\Omega$ , $V_{GE} = 10 \text{ V}$		40		A
U.I.S.	Functional Test Open Secondary Coil	$R_{GOFF} = 1 \text{ K}\Omega$ , $L = 1.6 \text{ mH}$ , $T_C = 125 \text{ }^\circ\text{C}$	20			A

## SWITCHING ON

Symbol	Parameter	Test Conditions	Min.	Typ.	Max.	Unit
$t_{d(on)}$ $t_r$	Turn-on Delay Time Rise Time	$V_{CC} = 320 \text{ V}$ , $I_C = 20 \text{ A}$ $R_G = 1 \text{ K}\Omega$ , $V_{GE} = 5 \text{ V}$		1 0.22		$\mu\text{s}$ $\mu\text{s}$
$(di/dt)_{on}$	Turn-on Current Slope	$V_{CC} = 320 \text{ V}$ , $I_C = 20 \text{ A}$ $R_G = 1 \text{ K}\Omega$ , $V_{GE} = 5 \text{ V}$		140		A/ $\mu\text{s}$
$E_{on}$	Turn-on Switching Losses	$V_{CC} = 320 \text{ V}$ , $I_C = 20 \text{ A}$ , $T_C = 25 \text{ }^\circ\text{C}$ $R_G = 1 \text{ K}\Omega$ , $V_{GE} = 5 \text{ V}$ , $T_C = 150 \text{ }^\circ\text{C}$		5 5.1		mJ mJ

## SWITCHING OFF

Symbol	Parameter	Test Conditions	Min.	Typ.	Max.	Unit
$t_c$	Cross-over Time	$V_{CC} = 320 \text{ V}$ , $I_C = 20 \text{ A}$ , $R_{GE} = 1 \text{ K}\Omega$ , $V_{GE} = 5 \text{ V}$		4.4		$\mu\text{s}$
$t_r(V_{off})$	Off Voltage Rise Time			2.5		$\mu\text{s}$
$t_{d(off)}$	Delay Time			12.1		$\mu\text{s}$
$t_f$	Fall Time			1.6		$\mu\text{s}$
$E_{off(**)}$	Turn-off Switching Loss			12.9		mJ
$t_c$	Cross-over Time	$V_{CC} = 320 \text{ V}$ , $I_C = 20 \text{ A}$ , $R_{GE} = 1 \text{ K}\Omega$ , $V_{GE} = 5 \text{ V}$ $T_j = 125 \text{ }^\circ\text{C}$		6		$\mu\text{s}$
$t_r(V_{off})$	Off Voltage Rise Time			3.16		$\mu\text{s}$
$t_{d(off)}$	Delay Time			13.4		$\mu\text{s}$
$t_f$	Fall Time			2.7		$\mu\text{s}$
$E_{off(**)}$	Turn-off Switching Loss			18.4		mJ

(1) Pulse width limited by max. junction temperature.

(\*\*) Losses Include Also the Tail

Output Characteristics

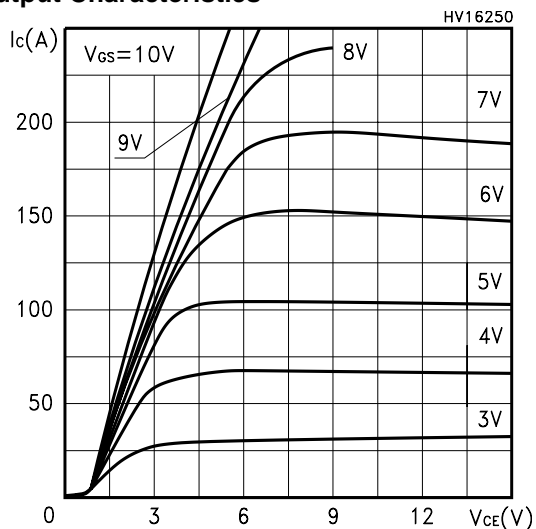

Transfer Characteristics

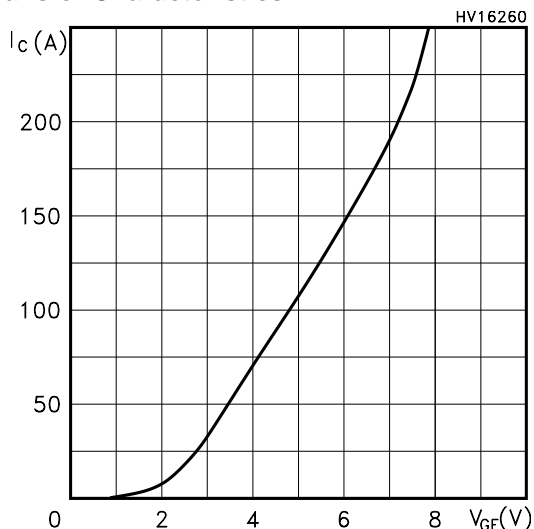

Normalized Gate Threshold Voltage vs Temp.

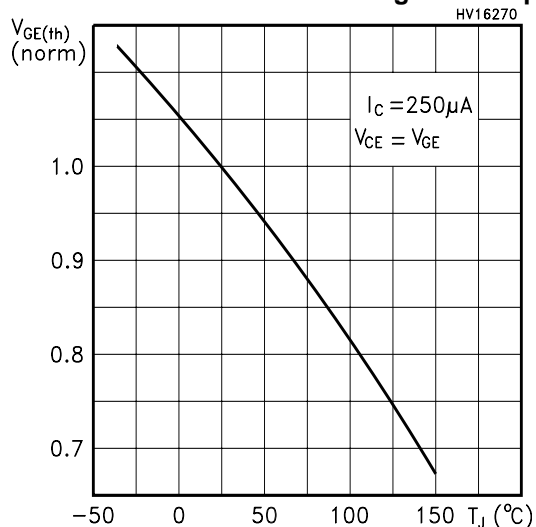

Transconductance

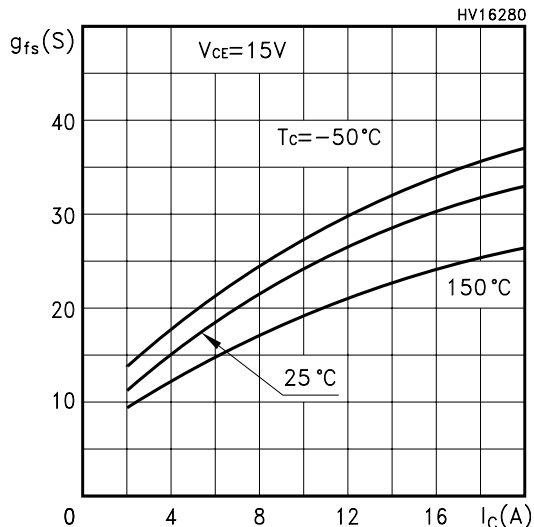

Normalized Collector-Emitter On Voltage vs Temperature

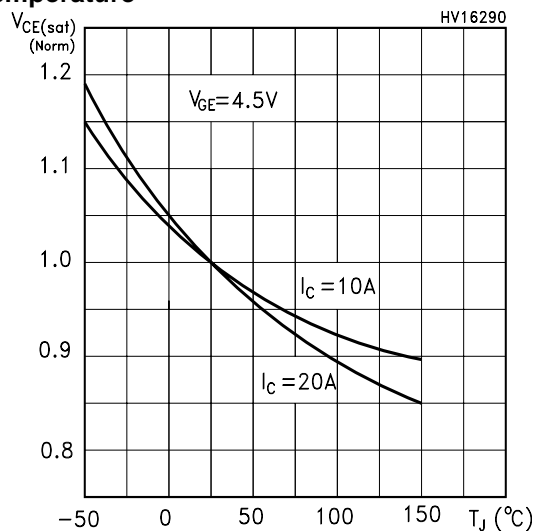

Normalized Collector-Emitter On Voltage vs Gate-Emitter Voltage

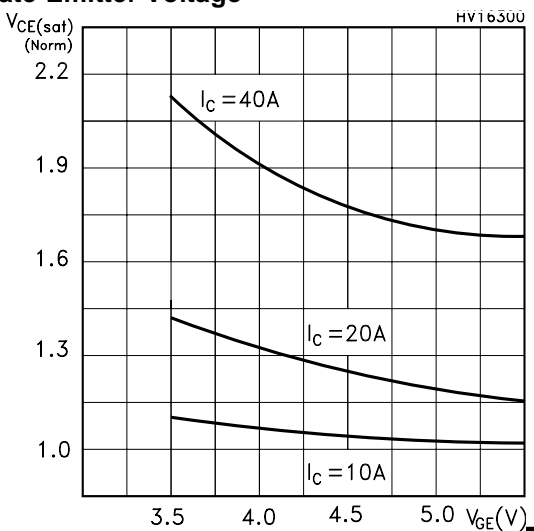

Capacitance Variations

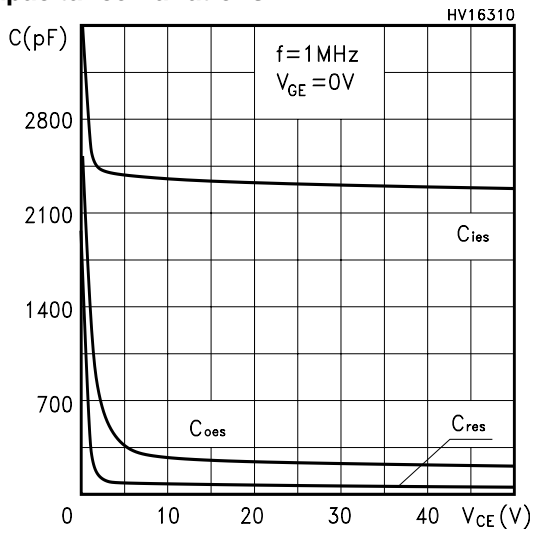

Gate Charge vs Gate-Emitter Voltage

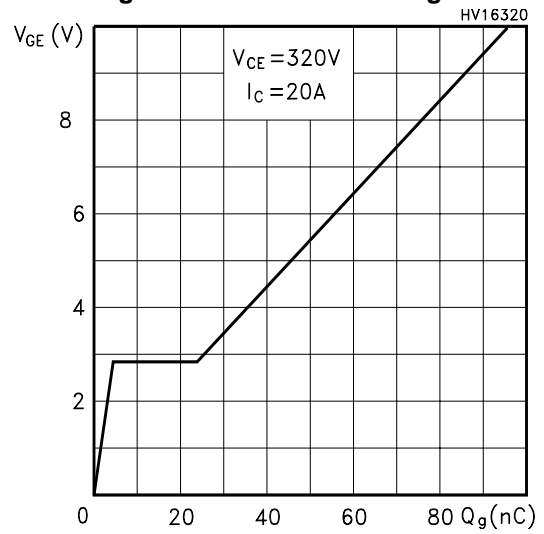

Off Losses vs Gate Resistance

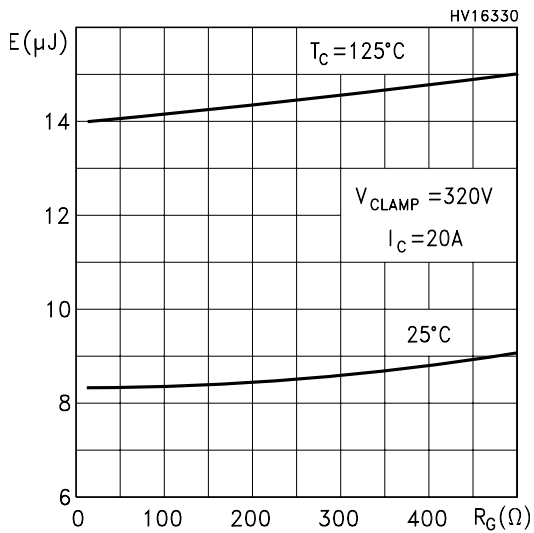

Off Losses vs Collector Current

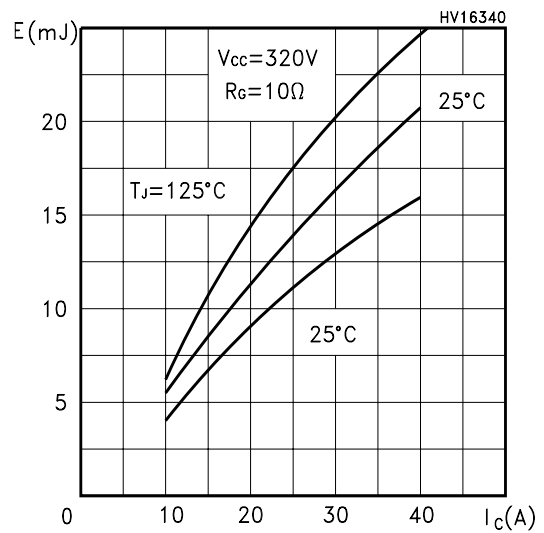

Normalized Break-down Voltage vs Temp.

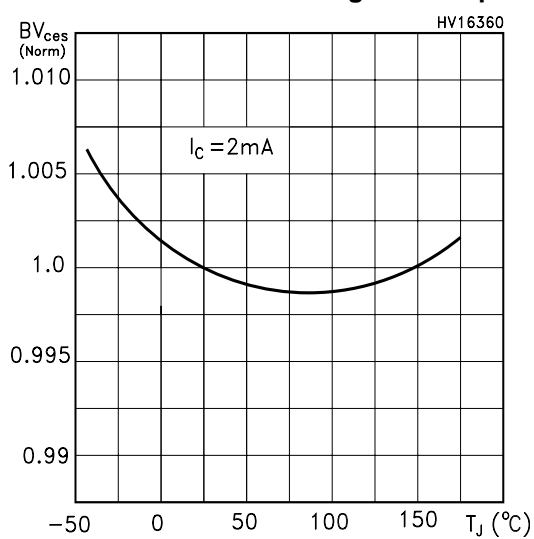

Normalized BVGE vs Temperature

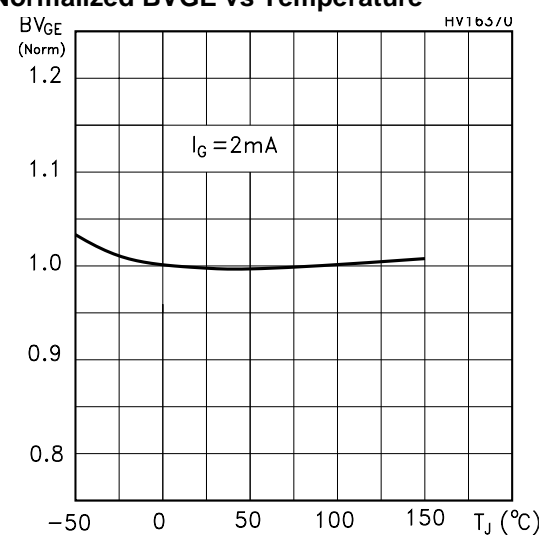

# STGB20NB41LZ

## Off Losses vs Temperature

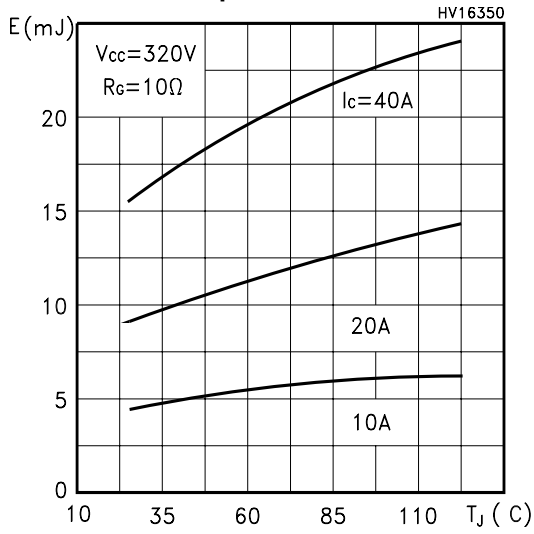

## Switching Off Safe Operating Area

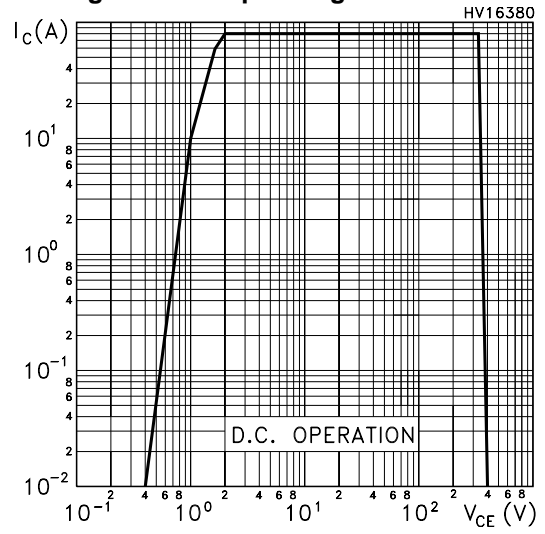

## Thermal Impedance

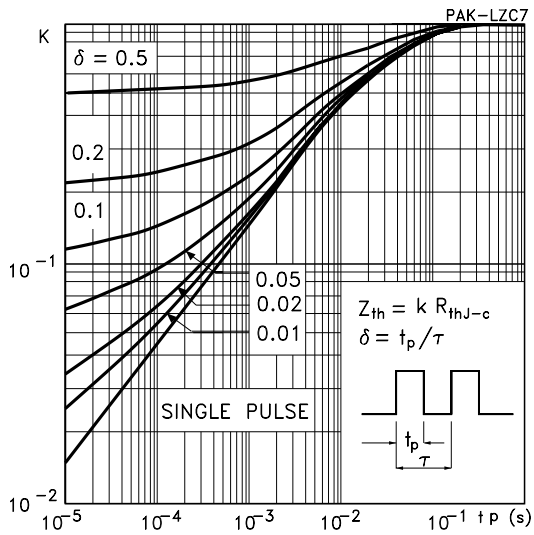

D<sup>2</sup>PAK MECHANICAL DATA

DIM.	mm.			inch		
	MIN.	TYP.	MAX.	MIN.	TYP.	MAX.
A	4.4		4.6	0.173		0.181
A1	2.49		2.69	0.098		0.106
A2	0.03		0.23	0.001		0.009
B	0.7		0.93	0.027		0.036
B2	1.14		1.7	0.044		0.067
C	0.45		0.6	0.017		0.023
C2	1.23		1.36	0.048		0.053
D	8.95		9.35	0.352		0.368
D1		8			0.315	
E	10		10.4	0.393		
E1		8.5			0.334	
G	4.88		5.28	0.192		0.208
L	15		15.85	0.590		0.625
L2	1.27		1.4	0.050		0.055
L3	1.4		1.75	0.055		0.068
M	2.4		3.2	0.094		0.126
R		0.4			0.015	
V2	0°		8°			

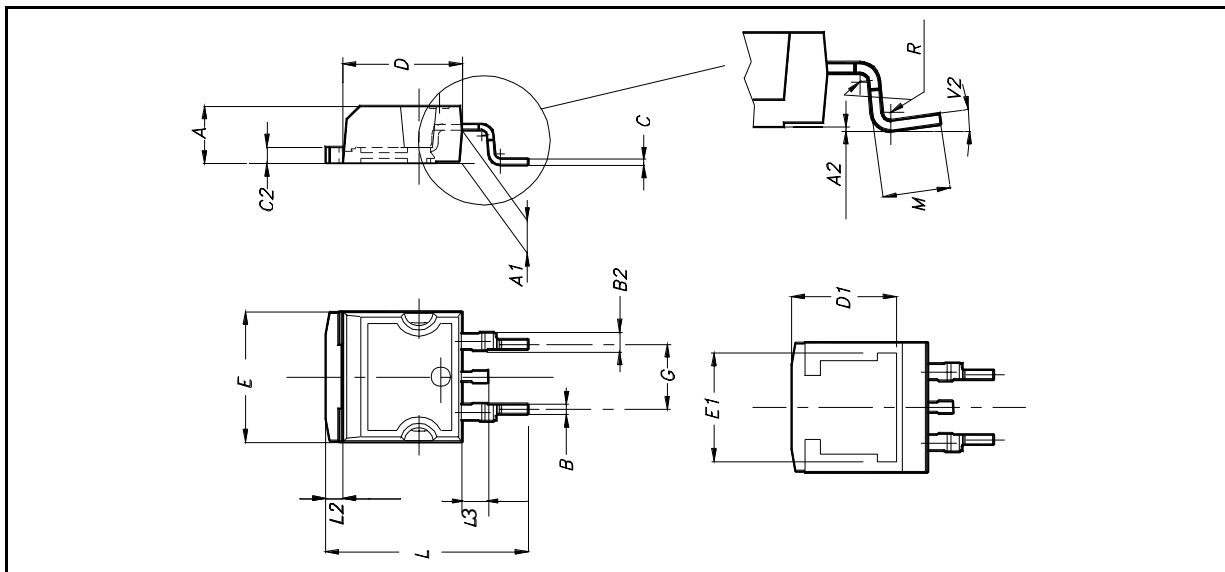

**D<sup>2</sup>PAK FOOTPRINT**

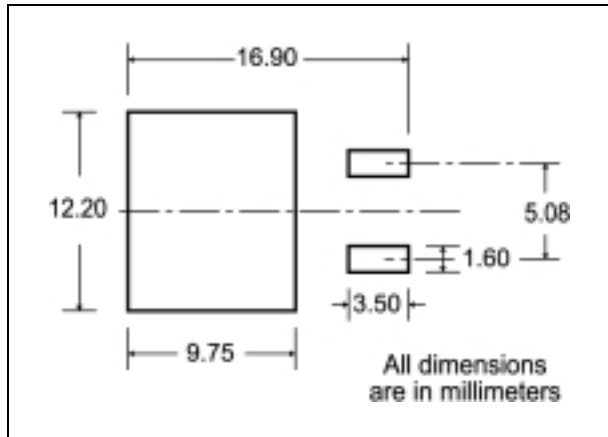

**TUBE SHIPMENT (no suffix)\***

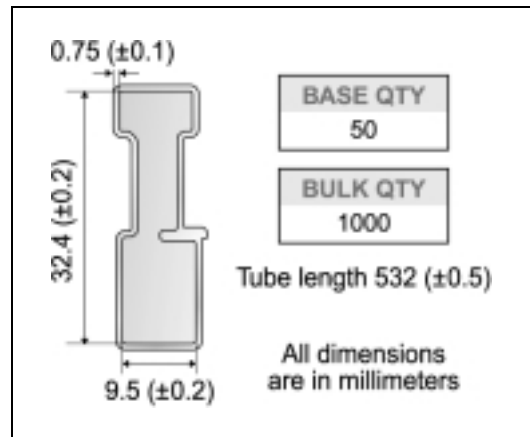

**TAPE AND REEL SHIPMENT (suffix "T4")\***

Diagram showing the tape mechanical data. Dimensions include A (overall width), B (lead width), C (lead thickness), D (lead height), and G (measured at hub). A 40 mm min. access hole is shown at the slot location. The tape slot in the core has a 2.5 mm min. width. The full radius is also indicated.

**TAPE MECHANICAL DATA**

DIM.	mm		inch	
	MIN.	MAX.	MIN.	MAX.
A0	10.5	10.7	0.413	0.421
B0	15.7	15.9	0.618	0.626
D	1.5	1.6	0.059	0.063
D1	1.59	1.61	0.062	0.063
E	1.65	1.85	0.065	0.073
F	11.4	11.6	0.449	0.456
K0	4.8	5.0	0.189	0.197
P0	3.9	4.1	0.153	0.161
P1	11.9	12.1	0.468	0.476
P2	1.9	2.1	0.075	0.082
R	50		1.574	
T	0.25	0.35	0.0098	0.0137
W	23.7	24.3	0.933	0.956

**REEL MECHANICAL DATA**

DIM.	mm		inch	
	MIN.	MAX.	MIN.	MAX.
A		330		12.992
B	1.5		0.059	
C	12.8	13.2	0.504	0.520
D	20.2		0.795	
G	24.4	26.4	0.960	1.039
N	100		3.937	
T		30.4		1.197

BASE QTY	BULK QTY
1000	1000

Diagram showing the reel mechanical data. Dimensions include P<sub>0</sub>, P<sub>1</sub>, P<sub>2</sub>, D, D<sub>1</sub>, D<sub>2</sub>, A<sub>0</sub>, A<sub>1</sub>, A<sub>2</sub>, B<sub>0</sub>, B<sub>1</sub>, B<sub>2</sub>, C, E, F, G, H, I, J, K, L, M, N, O, P, Q, R, S, T, U, V, W, X, Y, Z. The diagram also shows the user direction of feed, the center line of the cavity, and the bending radius (R min.).

\* on sales type  
8/9



Information furnished is believed to be accurate and reliable. However, STMicroelectronics assumes no responsibility for the consequences of use of such information nor for any infringement of patents or other rights of third parties which may result from its use. No license is granted by implication or otherwise under any patent or patent rights of STMicroelectronics. Specifications mentioned in this publication are subject to change without notice. This publication supersedes and replaces all information previously supplied. STMicroelectronics products are not authorized for use as critical components in life support devices or systems without express written approval of STMicroelectronics.

The ST logo is a registered trademark of STMicroelectronics  
All other names are the property of their respective owners

© 2004 STMicroelectronics - All Rights Reserved  
STMicroelectronics GROUP OF COMPANIES

Australia - Belgium - Brazil - Canada - China - Czech Republic - Finland - France - Germany - Hong Kong - India - Israel - Italy - Japan -  
Malaysia - Malta - Morocco - Singapore - Spain - Sweden - Switzerland - United Kingdom - United States.

<http://www.st.com>